

ASSEMBLY AND INSTALLATION INSTRUCTIONS

700 Lumens

WARNING: When using this lighting device, safety precautions should be followed at all times.

READ THE INSTRUCTIONS BELOW CAREFULLY AND FOLLOW THEM FOR YOUR OWN SAFETY!

1. This device is designed for indoor use. Do not use outdoors.
2. Prior to installation, battery connector must be open to prevent high voltage from being present on out put leads (red & yellow).
3. This device is designed for use with 17W–110W single pin or bipin fluorescent lamps, from 2' through 8'. Please use energy-saving circline, U-shaped, or 4-pin rapid start long compact fluorescent lamps.
4. Please ensure the electricity connections conforms to the National Electrical Code and local regulations if applicable.
5. To avoid electric shock, please disconnect normal and emergency power supplies, and battery connector of the emergency ballast before servicing.
6. This device is designed for factory or field installation in either the ballast channel, or on top of the indoor fixture, except air handling heated air outlets, wet or hazardous location fixtures. Do not install this device near gas or electric heaters.
7. AC power source of 120 VAC or 277 VAC is required.
8. The battery is sealed, non-maintenance, and is not replaceable in the field. Please contact manufacturer for information on service. Do not attempt to service the battery please.
9. Do not use accessory equipment that is not recommended by manufacturer. Failure to do so may cause unsafe conditions. Servicing should only be performed by qualified service personnel.
10. Do not use the product for other purpose that the product is NOT designed for.

PLEASE SAVE THESE INSTRUCTIONS

INSTALLATION INSTRUCTIONS

NOTE: All the branch circuit wiring has to be ready as well as an unswitched source of power before the fixture is installed.
Confirm the same branch circuit would be used for both the emergency ballast and the AC ballast.

CAUTION: Battery connector has to be opened for preventing high voltage on output leads (red and yellow).
Wait until the installation process has been completed and AC is supplying power to the emergency ballast, and then join the battery connector.

1. AC power has to be off before installation.
2. Choose the right wiring diagram to connect the ballast to the AC ballast and lamp.
3. Please ensure the electricity connections conform to the National Electrical Code and local regulations.
4. Follow diagrams 1 and 2 to install the battery pack on the top of the fixture or in the ballast channel.
5. To install the test switch, it would go through the side of a strip fixture or the ballast channel cover of a troffer. Follow diagrams 1 and 2 to drill a 1/2" hole and install the test switch. In order to remove AC power from both the emergency ballast and the AC ballast, the test switch has to be connected properly (see diagram 4).
6. Match violet and brown leads to connect the charging indicator light to the battery pack (see diagram 5). The charging indicator will be on after the fixture is installed properly.
7. Please search for a readily visible location to apply the CAUTION label which reads, "This unit has more than one power supply connection point. To reduce the risk of electric shock, disconnect both the branch circuit-breakers or fuses, and emergency power supply before servicing."
8. Do not join the inverter connector until the fixture is completely installed and supply AC power to the emergency ballast.
9. The battery needs to be charged for one hour in order to have short-term testing on the emergency function. Before having a long-term emergency function testing, the battery in the emergency ballast has to be charged for 24 hours.

DIAGRAM 1

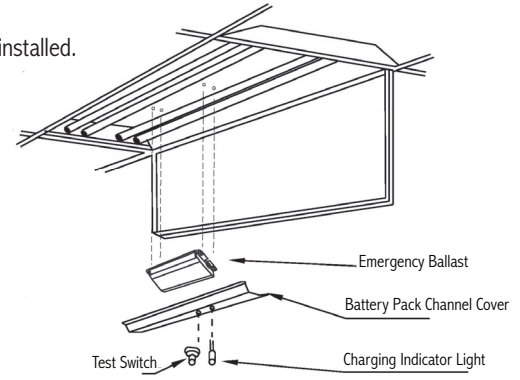

DIAGRAM 2

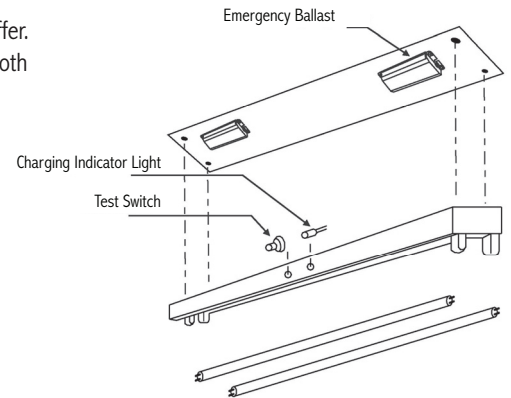

DIAGRAM 3

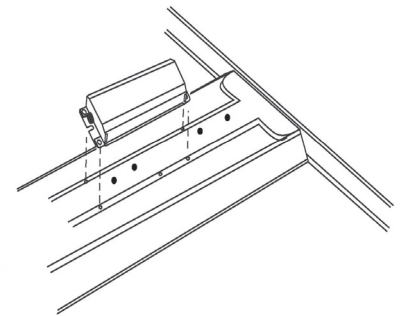

DIAGRAM 4

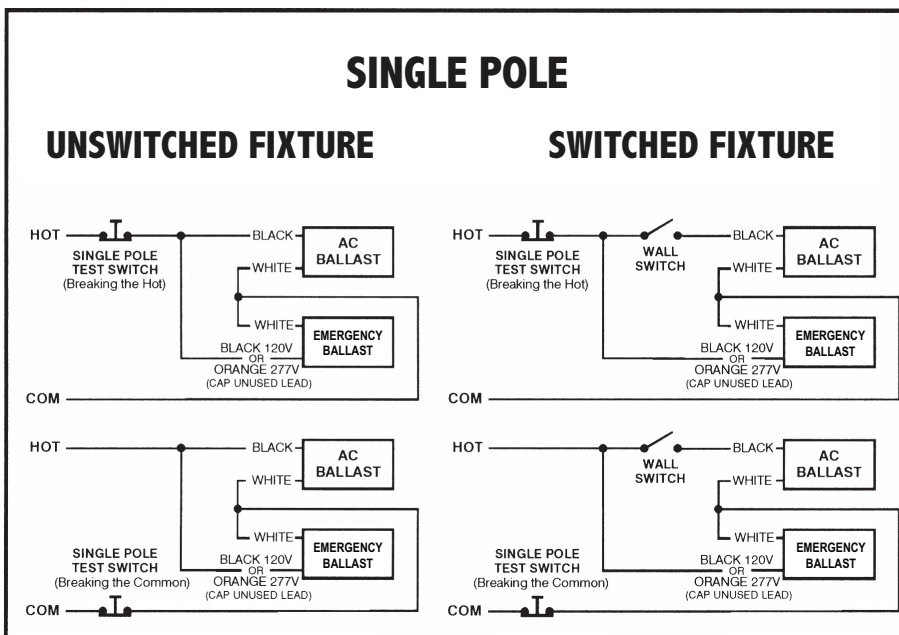
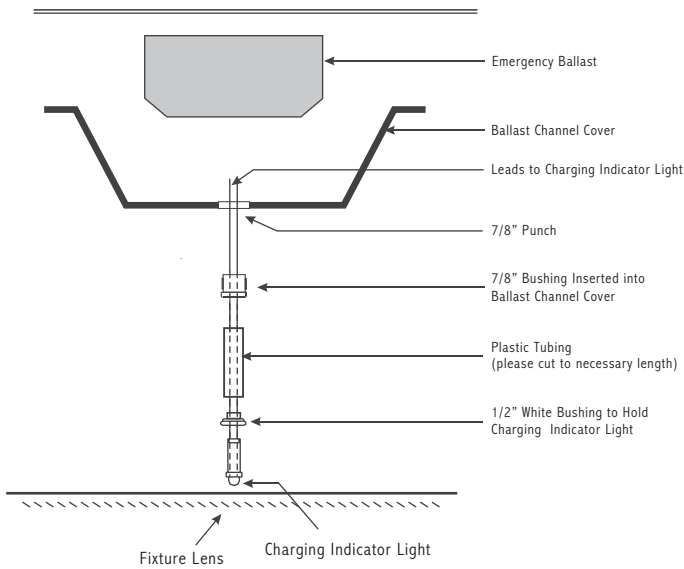
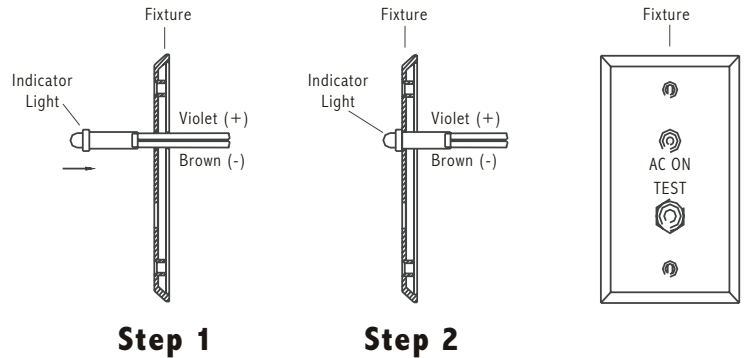

DIAGRAM 5

TROFFER-STYLE FIXTURE



OPTIONAL STRIP-STYLE FIXTURE



Operation

- The charging indicator light would be on to indicate the battery is being charged when AC power is applied.
- This emergency ballast would function and operate one or two lamps at least 90 minutes when the AC power is failed.

Maintenance

Note: Services should only be performed by qualified personnel. The emergency ballast should be checked periodically to confirm proper functioning and the following schedule is recommended:

1. To inspect the charging indicator every month and confirm that it is illuminated.
2. Push the test switch for 30 seconds to ensure the emergency ballast is functioning. Recommended to perform this testing every 30 days.
3. Perform a long-term test (90-minute battery discharge) at least once every year. One or two lamps should operate for no less than 90 minutes.

WIRING DIAGRAMS FOR 1- and 2-LAMP EMERGENCY OPERATION

EMERGENCY BALLAST AND AC BALLAST MUST BE FED FROM THE SAME BRANCH CIRCUIT

TYPICAL SCHEMATICS ONLY. MAY BE USED WITH OTHER BALLASTS. CONSULT THE FACTORY FOR OTHER WIRING DIAGRAMS.

For 1-Lamp Emergency Operation

A. INSTANT START AC BALLAST

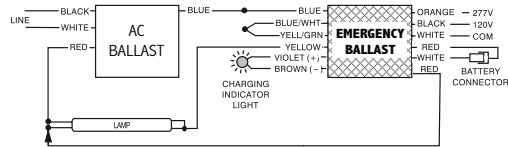

B. RAPID START AC BALLAST

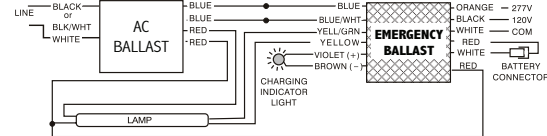

C. TWO-LAMP INSTANT START BALLAST

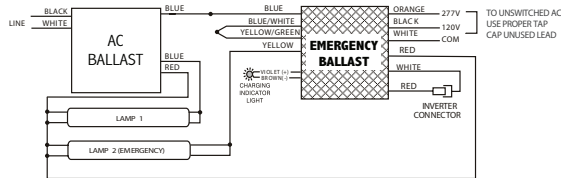

D. TWO-LAMP RAPID START BALLAST

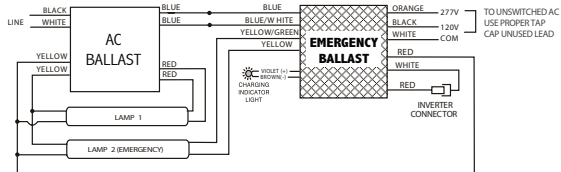

E. THREE-LAMP INSTANT START BALLAST

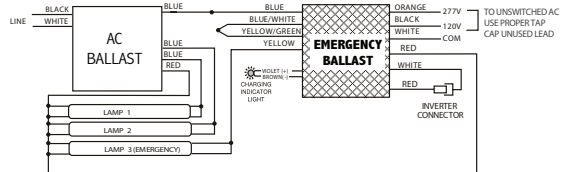

F. THREE-LAMP RAPID START BALLAST

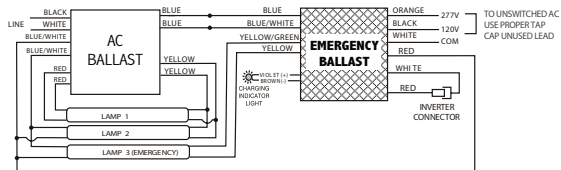

G. FOUR-LAMP INSTANT START BALLAST

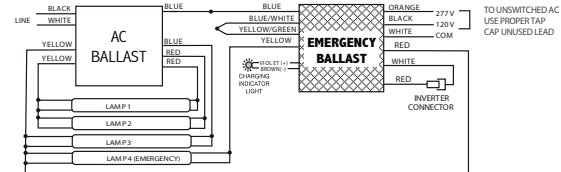

H. FOUR-LAMP RAPID START BALLAST

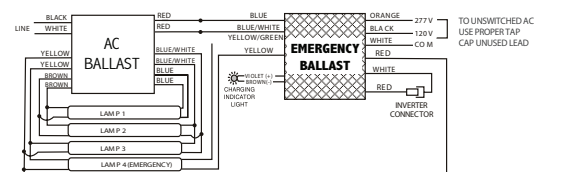

For 2-Lamp Emergency Operation

A. TWO-LAMP INSTANT START AC BALLAST

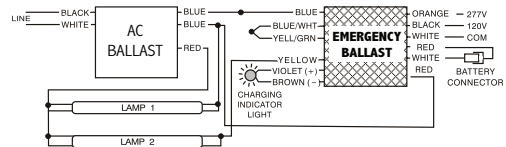

B. THREE-LAMP INSTANT START AC BALLAST

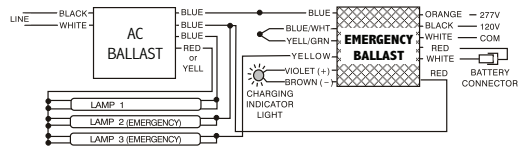

C. FOUR-LAMP INSTANT START AC BALLAST

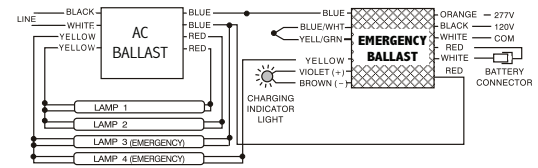

D. TWO-LAMP RAPID START AC BALLAST

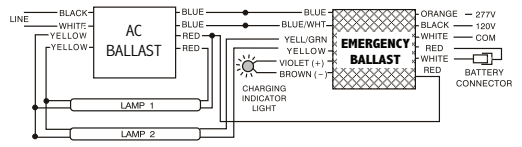

E. THREE-LAMP RAPID START AC BALLAST

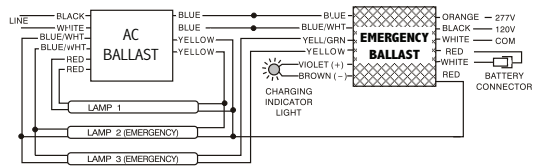

F. FOUR-LAMP RAPID START AC BALLAST

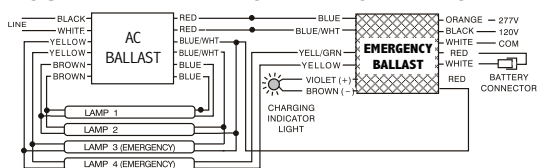

Emergency-Only Operation

A. ONE-LAMP WITHOUT AC BALLAST

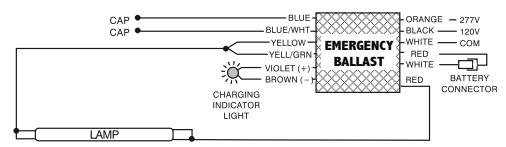

B. TWO-LAMP WITHOUT AC BALLAST

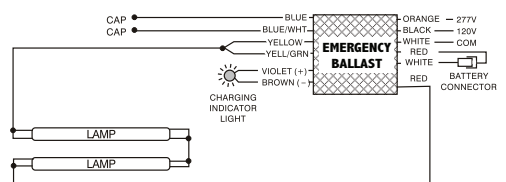

NOTE: Use the proper tap cap to unswitched AC lead.